

Grundlagen für DMS



Die mechanische Spannung an der Wellenoberfläche

Für die Dehnung gilt:

$$\varepsilon = \frac{\Delta l}{l} = \frac{8 \cdot Mt}{\pi \cdot G \cdot d^3} \cdot \sin 2\alpha$$

Unter $\alpha = 45^\circ$ hat ε größten Wert

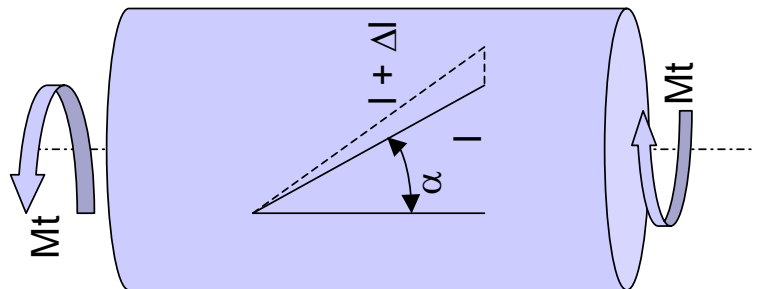

Für die mechanische Spannung gilt:

$$\tau_{\max} = \frac{16 \cdot Mt}{\pi \cdot d^3}$$

Mt = Drehmoment
d = Wellendurchmesser
G = Schubmodul

Dehnungen in ein elektrisches Signal

$$K = \frac{\Delta R / R}{\Delta l / l} = \tan \beta \approx 2$$

Damit folgt:

$$\frac{\Delta R}{R} = K \cdot \varepsilon = K \cdot \frac{8 \cdot Mt}{\pi \cdot G \cdot d^3}$$



Diagramm von Kelvin

170028a.ppt

Im Sensorbau verwendete DMS

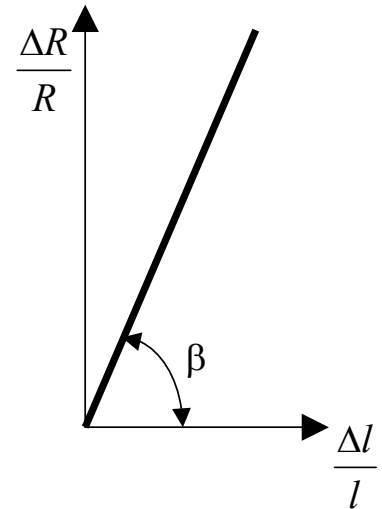
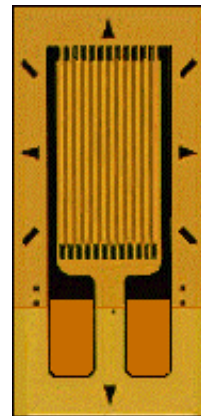
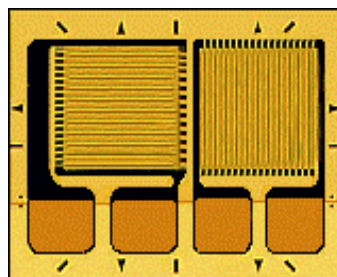

Weatston'sche Brückenschaltung Viertelbrücke

$$U_D = \frac{1}{2} \cdot U_B \cdot \varepsilon$$

ε in mm/m

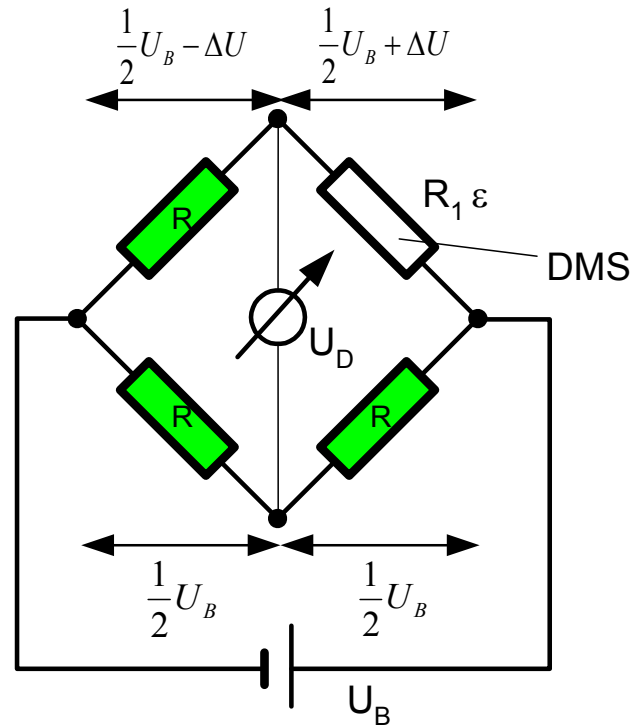

Weatston'sche Brückenschaltung Vollbrücke

$$U_D = 2 \cdot U_B \cdot \varepsilon$$

ε in mm/m

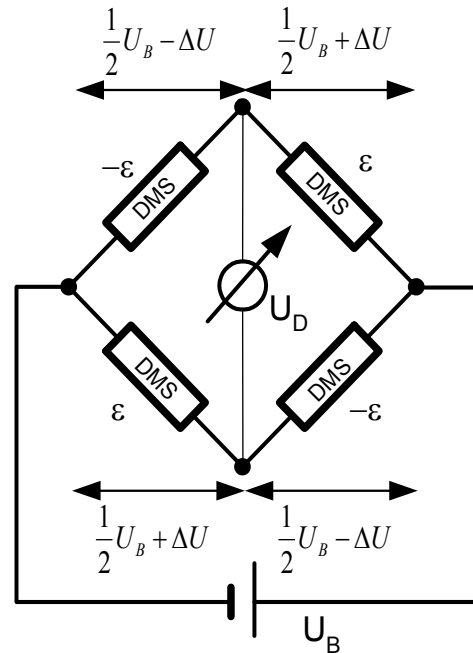

Beispiel für Vollbrücke

$$\varepsilon = 1 \frac{\text{mm}}{\text{m}} = 10^{-3}$$

Für die Vollbrücke gilt

$$U_D = 2 \cdot U_B \cdot \varepsilon$$

Für die Empfindlichkeit gilt

$$e_0 = \frac{U_D}{U_B} = 2 \cdot \varepsilon = 2 \cdot 10^{-3} = 2 \frac{\text{mV}}{\text{V}}$$

Bei $U_B = 10\text{V}$

$$U_D = U_B \cdot e_0 = 2 \cdot 10^{-3} \cdot 10\text{V} = 20 \cdot 10^{-3}\text{V}$$

$$U_D = 20\text{mV}$$

$$\frac{U_D}{U_B} = \frac{20\text{mV}}{10\text{V}} = 2 \frac{\text{mV}}{\text{V}}$$

E-Modul von Werkstoffen

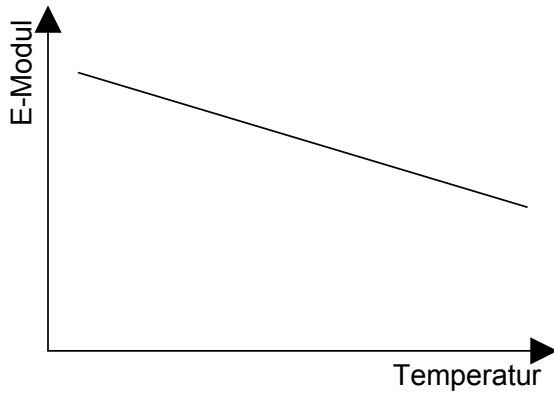

E-Modul nimmt ab mit zunehmender Temperatur

Stahl: $\frac{\Delta E}{100K} \approx (2 - 4\%) \cdot E$

Aluminium: $\frac{\Delta E}{100K} \approx (7\%) \cdot E$

$$\varepsilon \sim \frac{K}{E} \Rightarrow E - \text{Moduländerung geht Messsignal ein}$$



Schwingungen von Kraftsensoren



Steifigkeit von Kraftsensoren

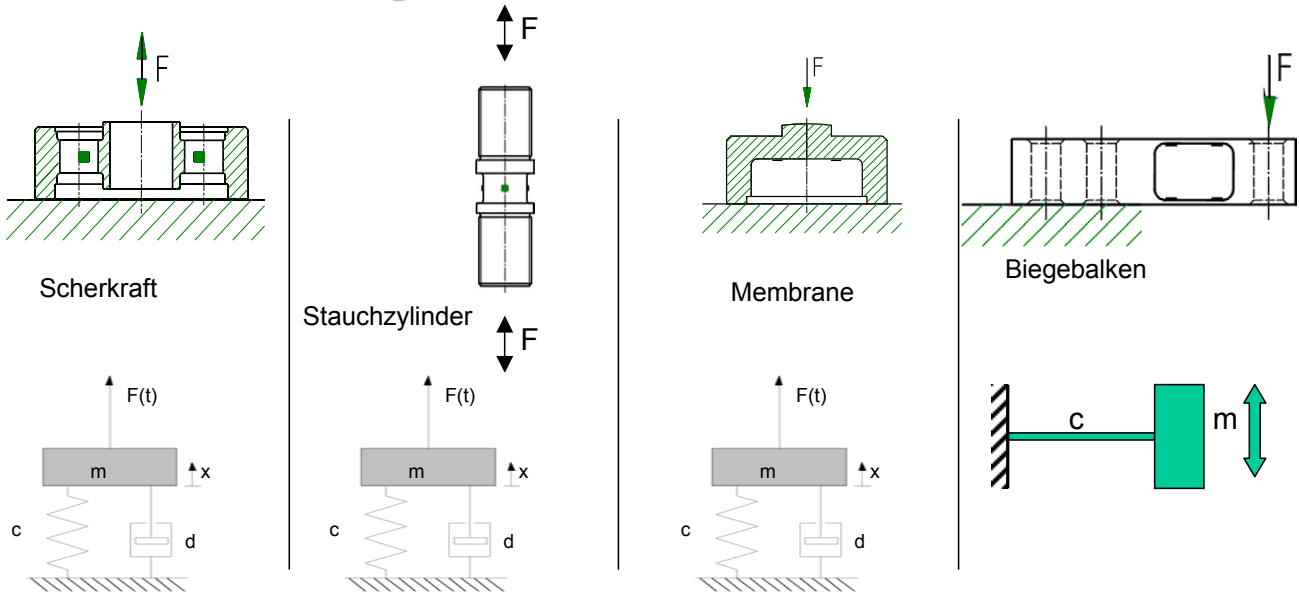

Berechnungsformel

$$f = \frac{1}{2\pi} \sqrt{\frac{1000 \cdot c}{m}}$$

f = Eigenresonanz
 c = Federkonstante in N/mm
 m = Masse in kg

Steifigkeit von Scherkraftaufnehmer

Project Name: Shear Beam 0 to 10 KN	Date: 28-Jun-95
Description: Example	ID: 14
INPUT VARIABLES	
Material: Stainless Steel 17-4PH (1.4548)	E: 2.00E+11 Pa
Load Range: 10,00 kN	v: 0,291
F = 10.000,00 N	
<p>The dimension "w" should as a rule of thumb be smaller than h / 8.</p> <p>This calculation can only give approximate value for the shear web thickness. Tests are needed to find the exact value.</p>	
SUGGESTED DEFAULT VALUES	
Bridge Configuration	
4 Active Gages	<input checked="" type="checkbox"/>
2 Active Gages	<input type="checkbox"/>
1 Active Gage	<input type="checkbox"/>
Gage Factor: 2,00	
Output-Signal: 2,3 mV/V	
Average ϵ: 1.150,00 $\mu\text{m/m}$	
Check-it!	$t = \frac{1,36 \cdot F \cdot (1 + \nu)}{E \cdot h \cdot \epsilon}$
Select a strain gage from list	
Strain Gage: FAED-12B-35-SXE-J	Quantity: 2
Alternative: FAED-06A-35-SXE-M	Quantity: 2
<p>All fields with yellow background must be filled in. Dimensions to be in millimeter (mm).</p>	

Übliche Werte für Durchbiegung: $y = 0,01$ bis $0,1$ mm

$$y = 1,15(\text{mm/m}) \times 20\text{mm} = 23\mu\text{m}$$

$$c = 10000\text{N} / 0,023\text{mm} = 4,3 \times 10^5 \text{N/mm}$$



Steifigkeit von Stauchzylinder

INPUT VARIABLES		SUGGESTED DEFAULT VALUES	
Material:	Stainless Steel 17-4PH (1.4548)	E:	2,00E+11 Pa
Load Range:	10.000,00 N	v:	0,291
<p>F = 10.000,00 N</p>		<p>Strain ?</p> <input type="checkbox"/> <input checked="" type="checkbox"/> <input type="checkbox"/>	
		<p>Bridge Configuration</p> <p>2 Active + 2 v <input checked="" type="checkbox"/></p> <p>1 Active + 1 v <input type="checkbox"/></p>	
		Gage Factor:	2,00
		Output-Signal:	1,00 mV/V
		Longitud. ϵ :	774,59 $\mu\text{m/m}$
		Check-it!	$A = \frac{F}{E \cdot \epsilon}$
		Cross Sectional Area (A):	64,550 mm ²
		ϵ transversal	225 $\mu\text{m/m}$
<p>The column should be made long enough so that a uniform strain field is established at the gage locations. As a rule of thumb the column should be 5 times as long as the widest cross sectional dimension.</p>		<p>Longitudinal deflection for a given basis length:</p> <p>L: 100,00 Delta-L: 0,08 mm</p>	
<p>Select a strain gage from list</p>			
Strain Gage:	FAET-A6194N-35-SXE	Quantity:	2
Alternative:	FAE-12S-35-SXE-J	Quantity:	

Übliche Werte für Durchbiegung: $y = 0,01$ bis $0,1\text{mm}$

$$c = 10000\text{N}/0,08\text{mm} = 1,25 \times 10^5 \text{N/mm}$$

Steifigkeit von Membrankraftaufnehmer

Übliche Werte für Durchbiegung: $y = 0,1$ bis $0,3\text{mm}$

$$F = 1000\text{N}$$

$$y = 0,1\text{mm}$$

$$c = 1000\text{N}/0,1\text{mm} = 1 \times 10^4 \text{N/mm}$$

Steifigkeit von Doppelbiegebalken

INPUT VARIABLES		SUGGESTED DEFAULT VALUES	
Material:	Stainless Steel 17-4PH (1.4548)	E:	2,00E+11 Pa
Load Range:	100,00 N	v:	0,291
F= 100,00 N		Bridge Configuration 4 Active Gages <input checked="" type="checkbox"/> 2 Active Gages <input type="checkbox"/> 1 Active Gage <input type="checkbox"/>	
		Gage Factor: 2,00 Output-Signal: 2,2 mV/V Average ϵ : 1.100,00 $\mu\text{m/m}$	
Grid center line: 25,00 33,00		Deflection(Y): 0,45 mm	
All fields with yellow background must be filled in. Dimensions to be in millimeter (mm).			
Select a strain gage from list			
Strain Gage:	FAE2-A6174J-35-SXE	Quantity:	2
Alternative:	FAE-12S-35-SXE-J	Quantity:	
Check-it! $t = \sqrt{\frac{1,4 \cdot F \cdot l_1}{E \cdot \epsilon \cdot W}}$ $Y = \frac{F \cdot l_2^3}{2 \cdot E \cdot W \cdot t^3}$			

Übliche Werte für Durchbiegung: $y = 0,5$ bis 1mm

$$c = 100\text{N}/0,45\text{mm} = 2,2 \times 10^3 \text{N/mm}$$

Eigenresonanz bei $m = 1\text{kg}$

<p>Scherkraft</p>	<p>Stauchzylinder</p>	<p>Membrane</p>	<p>Biegebalken</p>
<p>$m = 1\text{ kg}$ $c = 4,3 \times 10^5 \text{ N/mm}$ $f = 3280\text{ Hz}$</p>	<p>$m = 1\text{ kg}$ $c = 1,25 \times 10^5 \text{ N/mm}$ $f = 1768\text{ Hz}$</p>	<p>$m = 1\text{ kg}$ $c = 1 \times 10^4 \text{ N/mm}$ $f = 500\text{ Hz}$</p>	<p>$m = 1\text{ kg}$ $c = 2,2 \times 10^3 \text{ N/mm}$ $f = 235\text{ Hz}$</p>

Durchbiegung bzw. Messweg der Sensoren

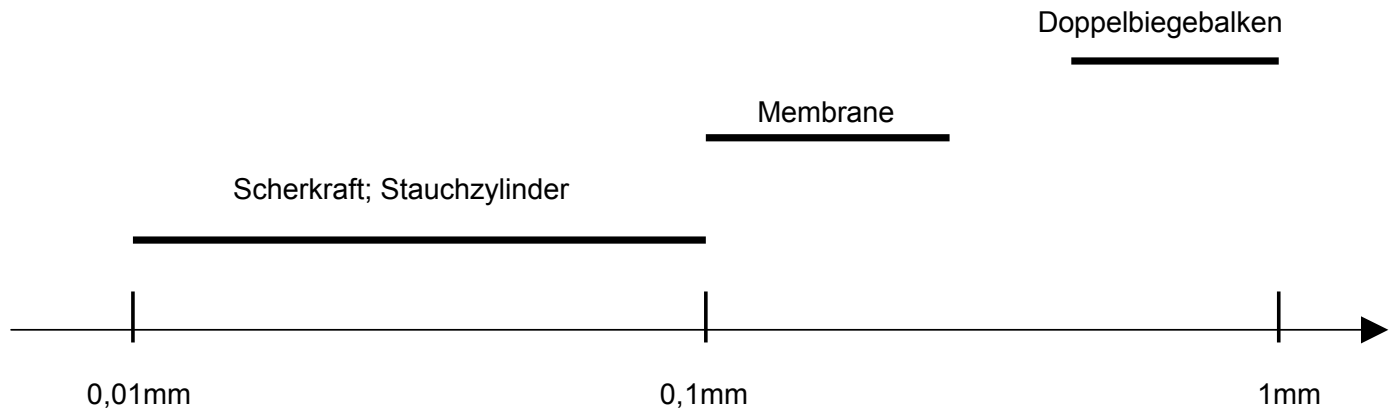

Die Sprungfunktion

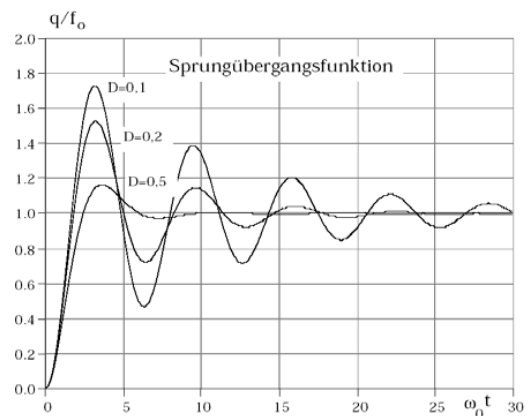
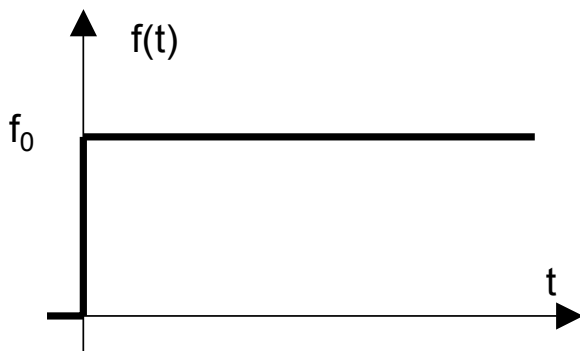

Maximale Sprungantwort:
2x Sprunghöhe
abhängig von der Dämpfung

Die Eigenresonanz

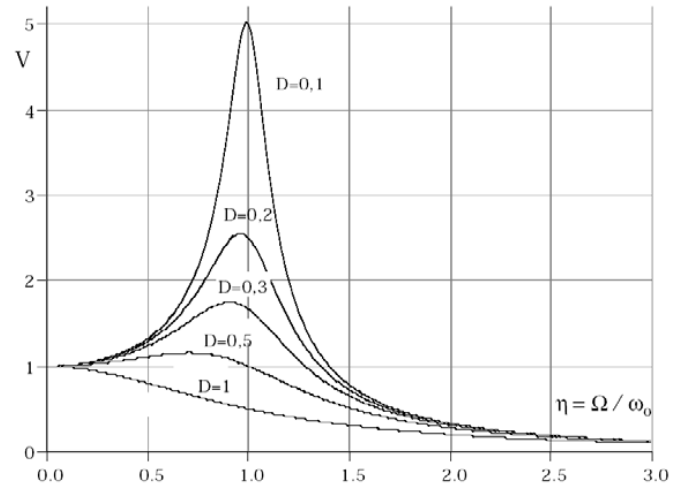
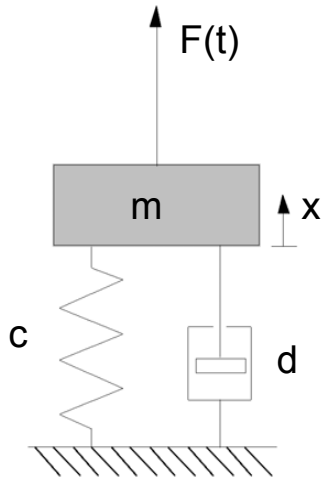

Amplitude je nach Dämpfung 5 - 10x Eingangsamplitude

Anregung der Eigenschwingung

